

2014
—
2015

GP Fiber Optics GmbH

NEUHEITEN

Das Licht für neue Ideen

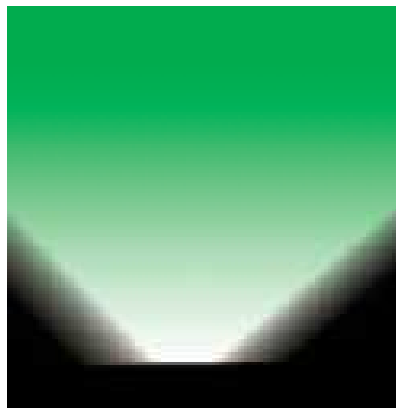
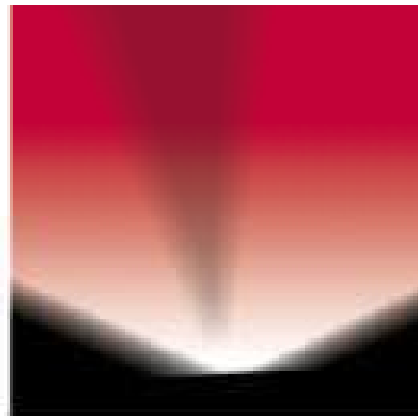

Magneto Linie

Nach der erfolgreichen Einführung der MAGNETO Serie haben wir die Produktlinie erweitert, um unseren Kunden eine noch individuellere Lichtlösung für den Bereich Museum, Vitrinen und Verkaufsräume anbieten zu können. Die Serie erlaubt eine flexible und innovative Kombination aus verschiedenen LED Elementen. Die MAGNETO Schiene ist in verschiedenen Längen verfügbar. Die LED Elemente, die in drei verschiedenen Lichtfarben (Warmweiß, Naturweiß oder Kaltweiß) lieferbar sind, können anschließend ohne weitere Hilfsmittel oder Werkzeuge frei, und eben magnetisch, platziert werden. Zusätzlich wurde das Programm um eine DMX Variante ergänzt.



MAGNETO IV



Magnetopunkt 2W

- Leistung 2W
- Spannung 20 Vdc
- Lumen max. 95 lm
- Optik 100°



Magnetopunkt 5W

- Leistung 5W
- Spannung 20 Vdc
- Lumen max. 370 lm
- Optik 100°



Magnetospot 2W / 4,5W

- Leistung 2W/4,5W
- Spannung 20 Vdc
- Lumen max. 95-220 lm
- Optik 10°, 25° oder 40°



Magnetospot 4,5W Fokus

- Leistung 4,5W
- Spannung 20 Vdc
- Lumen max. 220 lm
- Optik variabel 20° - 60°



Magnetospot 2W Fokus Beam

- Leistung 2W
- Spannung 20 Vdc
- Lumen max. 95 lm
- Optik variabel 8° - 20°

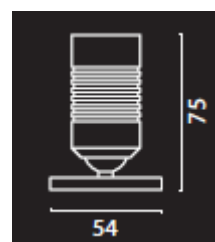
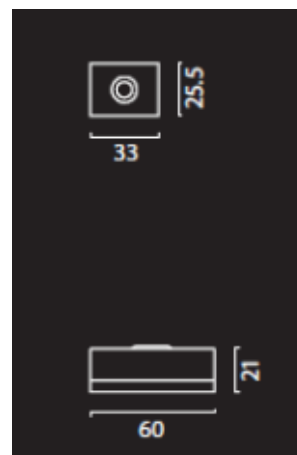

MAGNETO IV



Magneto SPOT 5W Fokus

- Leistung 5W
- Spannung 20 Vdc
- Lumen max. 370 lm
- Optik variabel 20° - 60°

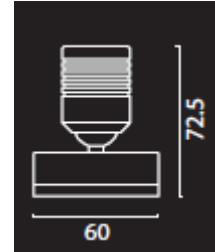

Magneto SPOT 6,5W

- Leistung 6,5W
- Spannung 20 Vdc
- Lumen max. 370 lm
- Optik 10°, 25° oder 40°

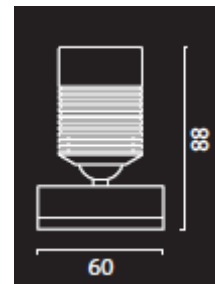

Magneto SCHIENE

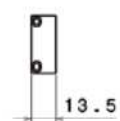
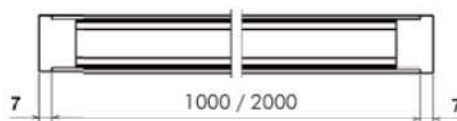
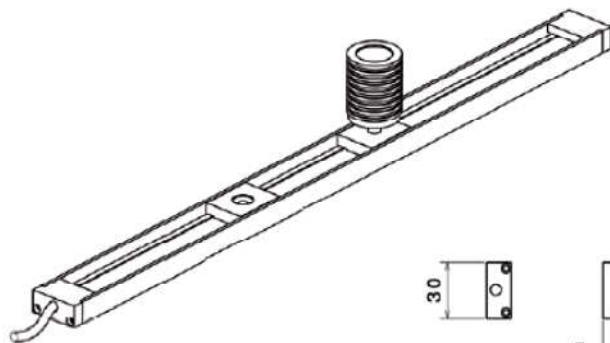
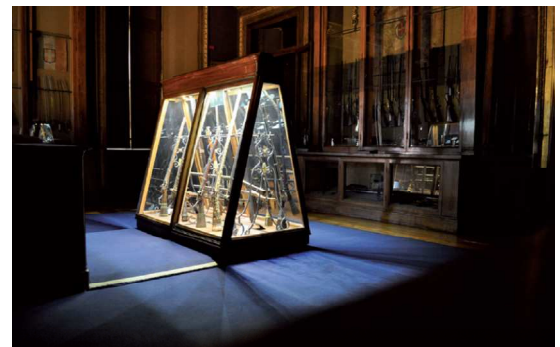

CE

MAGNETO V



Magneto V PUNKT 5W

- Leistung 5W
- Spannung 24 Vdc
- Lumen max. 370 lm
- Optik 100°

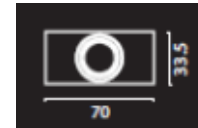

Magneto V SPOT 5W Fokus

- Leistung 5W
- Spannung 24 Vdc
- Lumen max. 370 lm
- Optik 20° - 60°

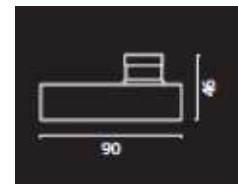

Magneto V SPOT 7W

- Leistung 7W
- Spannung 24 Vdc
- Lumen max. 370 lm
- Optik 10°, 25° oder 40°

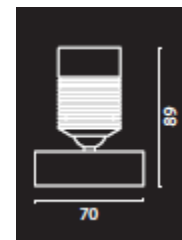

Magneto V SPOT 7,5W Fokus

- Leistung 7,5W
- Spannung 24 Vdc
- Lumen max. 500 lm
- Optik 20° - 60°



ART BRUT



Die ART BRUT Serie ist ein neues Konzept zur Beleuchtung von Museums Ausstellungen, Verkaufsfächen und Show Räumen. Die ART BRUT Lichtelemente sind mit State-of-the-Art POWER LED Technologie bestückt, die eine hervorragende Lichtleistung und geringe Energiekosten gewährleisten. Mit ihrer hohen Farbwiedergabe (> 90) ist eine perfekte chromatische Wahrnehmung gesichert, und die große Auswahl an verschiedenen Farbtemperaturen ermöglicht eine sehr flexible und kreative Auswahl der Lichtquellen.

Die ART BRUT Strahler werden entweder mit einem Schienenadapter oder einer Deckenhalterung geliefert und können alle gedimmt werden. Die DMX Version erlaubt sogar eine Dimmung der Einzelstrahler über eine Fernbedienung.



ART BRUT Nano 7W o. 12W Fokus

- Leistung 7W oder 12W
- Spannung 230V
- Lumen max. 500lm oder 870lm
- Optik 20° - 60°

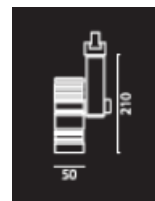

ART BRUT Mini 25W

- Leistung 25W
- Spannung 230V
- Lumen max. 1790lm
- Optik 10°, 17°, 40° oder 60°



ART BRUT Mini 20W Fokus

- Leistung 20W
- Spannung 230V
- Lumen max. 1480lm
- Optik 20° - 60°



ART BRUT 20W oder 20W Fokus

- Leistung 20W
- Spannung 230V
- Lumen max. 1200lm
- Optik 10°, 25° oder 40°
- Optik 20° - 60° (Fokus Variante)



Brut

Fokus

LED Vitrinen Strahler



CRICKET

- Leistung 3W
- Netzteil 350mA
- Lumen 250lm – 330lm
- Optik 40°

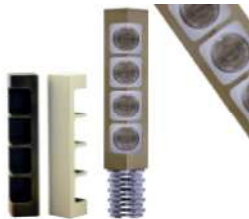
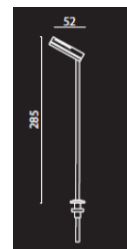

PRYSM

- Leistung 4W
- Netzteil 350mA
- Lumen 330lm – 440lm
- Optik 10°, 25° oder 40° (Eliptisch)



STYLO

- Leistung 4W
- Netzteil 350mA
- Lumen 330lm- 440lm
- Optik 110°

